

EXTENSIONS D'ANGLE H2452

AVEC FILEUR SUPPORT ANGLE

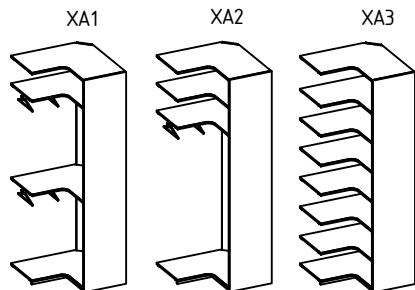

AVEC FOND D'ANGLE

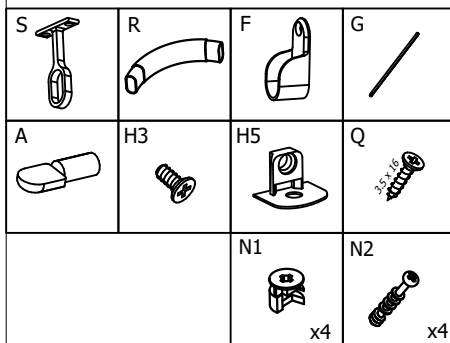
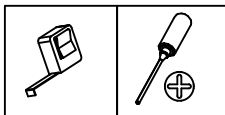
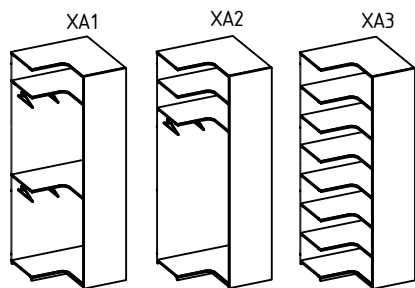

FILEUR SUPPORT ANGLE

TABLETTE FIXE

FOND D'ANGLE

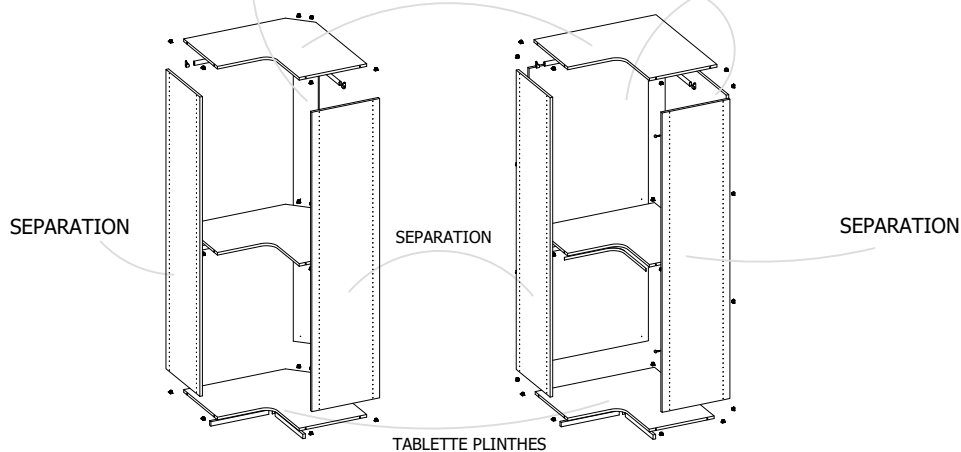

1

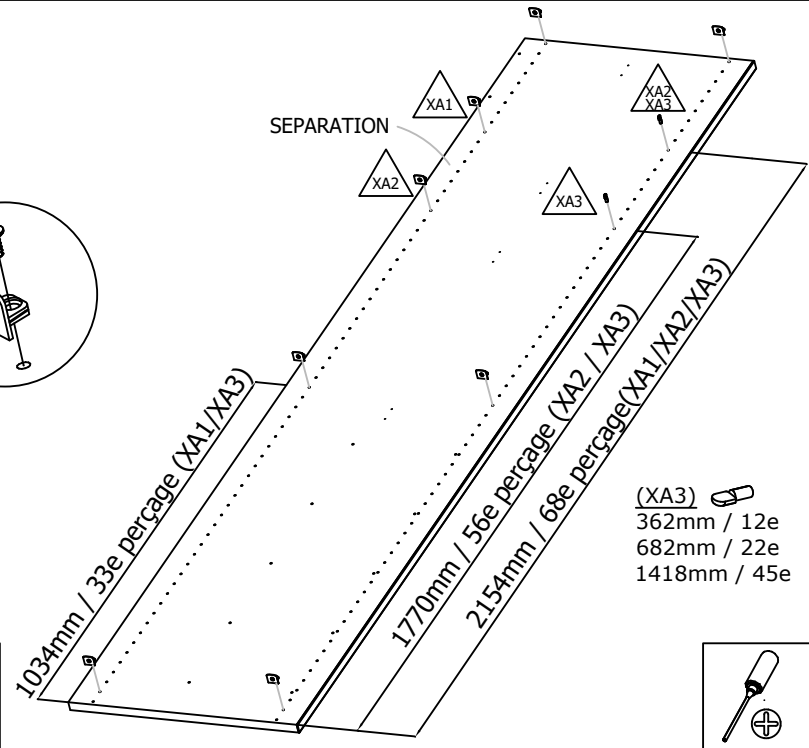
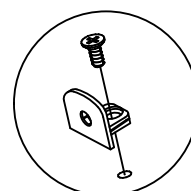

(XA3)
362mm / 12e
682mm / 22e
1418mm / 45e

2

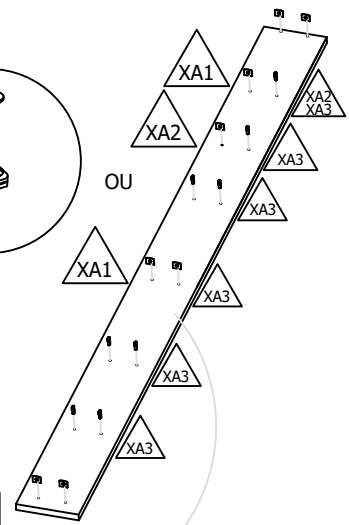
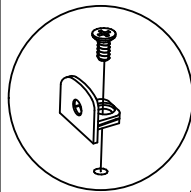

FILEUR SUPPORT ANGLE

FOND D'ANGLE

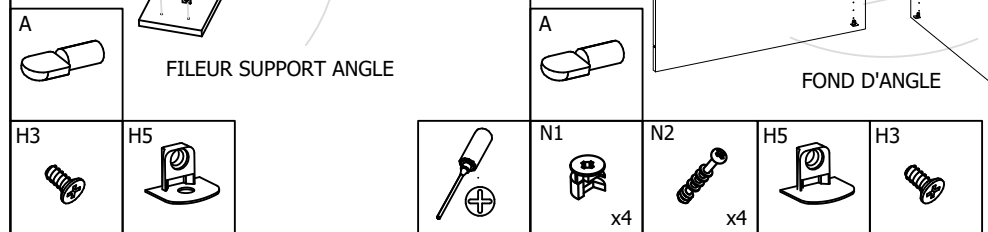

3

FILEUR SUPPORT ANGLE

FOND D'ANGLE

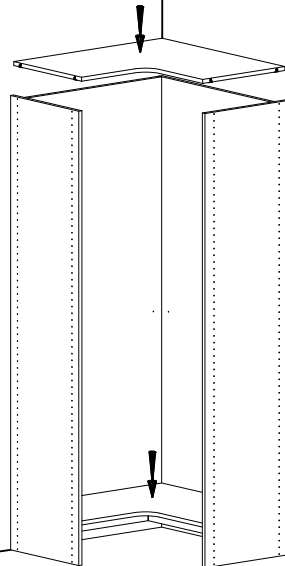
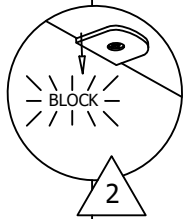
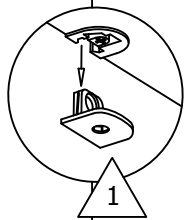
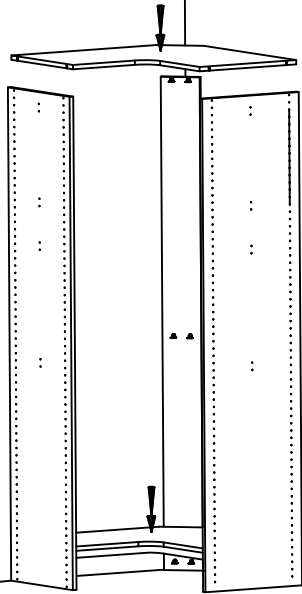

4

TABLETTE FIXE

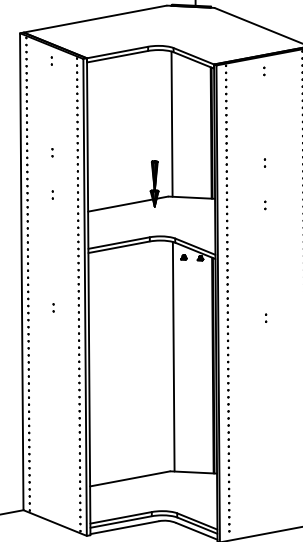
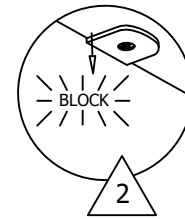
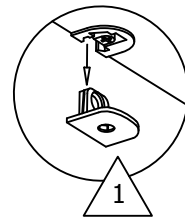

5

PENDERIES

T = COTE DE POSITION TRIANGLE

FILEUR SUPPORT D'ANGLE T = 637
FOND D'ANGLE T = 627

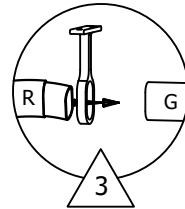
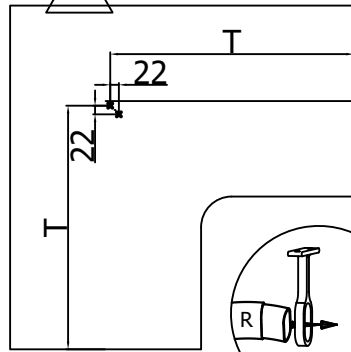
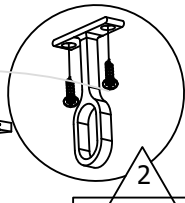
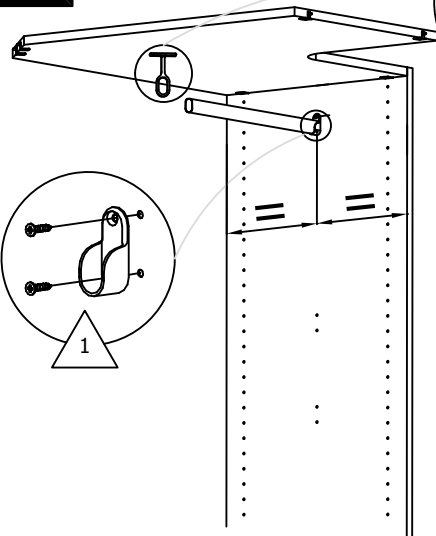

6

